

Sanitary pressure gauge

Model: P750 series

Spec. sheet no. PD07-04

Service intended

P750 series have diaphragm seal to be combined with a pressure gauge. These series are suitable to be used for the situation where corrosive, contaminated, hot, and viscous pressure mediums are present, and it could be used for a chemical, food, beverage, biochemical, and pharmaceutical industry.



Nominal diameter

63, 80 and 100 mm

Accuracy

63 and 80 mm : $\pm 1.6\%$ of full scale

100 mm : $\pm 1.0\%$ of full scale

Pressure range (MPa, kPa, bar)

Steady : 75% of full scale (63 and 80 mm)

100% of full scale (100 mm)

Over range protection : 130% of full scale

Working pressure

Steady : 75% of full scale

Over range protection : 130% of full scale

Working temperature

Ambient : $-20 \sim 65^{\circ}\text{C}$

Fluid : Max. 121°C

Temperature effect

Accuracy at temperature above and below the reference temperature (20°C) will be effected by approximately $\pm 0.5\%$ per 10°C of full scale



Model : P751



Model : P752



Model : P753



Model : P754



Model : P755



Model : P756

Standard features

Process connection

316SS

P751 : $1\frac{1}{2}$ " and 2" Nut

P752 : 1", $1\frac{1}{2}$ ", 2", clamp connection

P753 : PF $\frac{3}{4}$ ", PF1", PF1 $\frac{1}{2}$ ", male screw

P754 : Standard and non standard flange

P755 : Homogenizer

P756 : Homogenizer flange (95 x 43 x 28)

System filling

Food grade oil (FDA certified)

Certificates

ATEX Ex II GD c IIC TX

Body

Stainless steel (316SS)

Diaphragm

Stainless steel (316L SS)

Electropolished diaphragm

Ra 12 ~ 20 μm

1. Base model

P751	Nut type sanitary pressure gauge
P752	Clamp (IDF flange) type sanitary pressure gauge
P753	Male screw type sanitary pressure gauge
P754	Cooling fin type sanitary pressure gauge
P755	Homogenizer type sanitary pressure gauge
P756	Homogenizer flange type sanitary pressure gauge

2. Gauge model and mounting type

7A	63 mm, bottom connection
7U	80 mm, bottom connection
8A	100 mm, bottom connection
7G	63 mm, lower back connection, only available with P751 and P752
7V	80 mm, lower back connection, only available with P751 and P752
8G	100 mm, lower back connection, only available with P751 and P752
7P	63 mm, bottom connection, liquid filling
8U	80 mm, bottom connection, liquid filling
8P	100 mm, bottom connection, liquid filling
7T	63 mm, lower back connection, only available with P751 and P752, liquid filling
8V	80 mm, lower back connection, only available with P751 and P752, liquid filling
8T	100 mm, lower back connection, only available with P751 and P752, liquid filling

3. Body and process connection material, pocket length

D	316SS
----------	-------

4. Process connection

NA	1" Nut, only available with P751
NB	1½" Nut, only available with P751
NC	2" Nut, only available with P751
FB	¾"PF, only available with P753
GB	1"PF, only available with P753
JB	1½"PF, only available with P753
GN	1" Clamp, only available with P752
JN	1½" Clamp, only available with P752
KN	2" Calmp, only available with P752
MN	2.5", only available with P752
LN	3", only available with P752
PU	Homogenizer, only available with P755
PS	Homogenizer flange (95 x 43 x 28), only available with P756
PN	Standard flange, only available with P754
PM	Non standard flange, only available with P754 (See note2)
ZZ	Other

Note 1. Max. temperature and process of pressure medium must be specified on order sheet.

2. Flange size will be specified on order sheet.

5. Unit

H	bar
I	MPa
J	kPa

6. Range

XXX	Refer to pressure range table
------------	-------------------------------

7. Diaphragm material

E	316L SS
----------	---------

8. Options

0	None
1	Accessories

1	2	3	4	5	6	7	8
P751	1A	D	FB	H	XXX	E	0

Sample
ordering code

P75X : Type of mounting

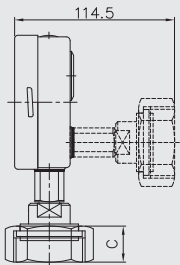
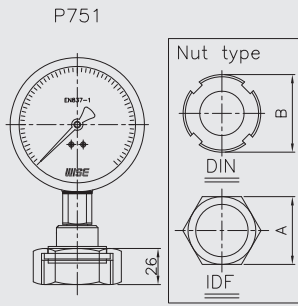

	1S	1.5S	2S	1S
A	45	56	75	90
B	48	64	77	91
C	30	30	30	30

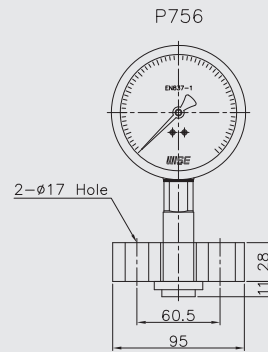
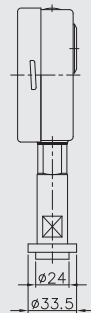
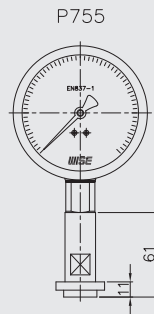
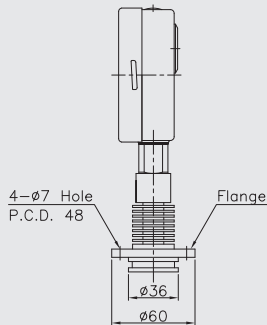
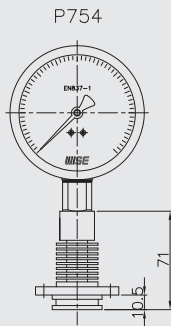
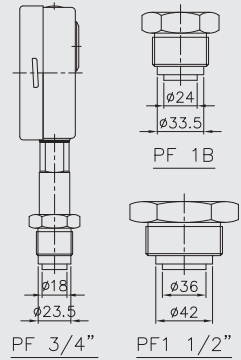
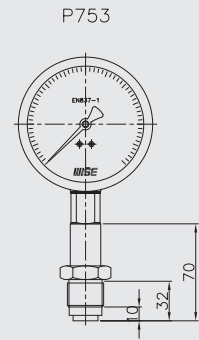
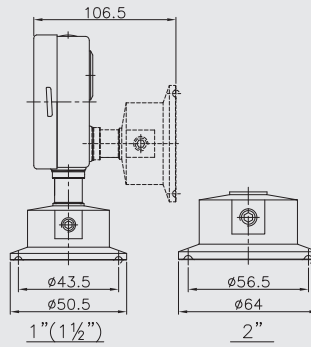
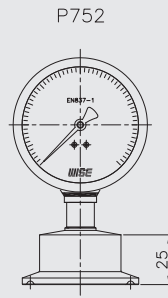

Pressure unit and range table

Range and code	Unit and code			P751		P752			P753			P754	P755	P756
	H : bar	J : kPa	I : MPa	1½"	2"	1"	1½"	2"	PF ¾"	PF 1"	PF 1½"			
041	0~1	0~100	0~0.1	X	O	X	O	O	X	X	X	X	X	X
133	0~1.6	0~160	0~0.16	X	O	X	X	O	X	X	X	X	X	X
042	0~2	0~200	0~0.2	O	O	O	O	O	X	X	X	O	X	X
134	0~2.5	0~250	0~0.25	X	O	X	X	O	X	X	X	X	X	X
043	0~3	0~300	0~0.3	O	O	O	O	O	X	X	X	O	X	X
044	0~4	0~400	0~0.4	O	O	O	O	O	X	X	O	O	X	X
045	0~6	0~600	0~0.6	O	O	O	O	O	X	X	O	O	X	X
047	0~10	0~1,000	0~1	O	O	O	O	O	X	X	O	O	X	X
050	0~15	X	0~1.5	O	O	O	O	O	X	X	O	O	X	X
051	0~20	X	0~2	O	O	O	O	O	X	X	O	O	X	X
052	0~25	X	0~2.5	O	O	O	O	O	X	X	O	O	X	X
054	0~35	X	0~3.5	O	O	O	O	O	X	O	O	O	X	X
055	0~50	X	0~5	O	O	O	O	O	X	O	O	O	X	X
057	0~70	X	0~7	X	X	X	X	X	O	O	O	O	O	O
058	0~100	X	0~10	X	X	X	X	X	O	O	O	O	O	O
059	0~150	X	0~15	X	X	X	X	X	O	O	O	X	O	O
062	0~250	X	0~25	X	X	X	X	X	O	O	O	X	O	O
064	0~350	X	0~35	X	X	X	X	X	O	O	O	X	O	O
065	0~400	X	0~40	X	X	X	X	X	O	O	O	X	O	O
066	0~500	X	0~50	X	X	X	X	X	O	O	O	X	O	O

O : Available X : Not available