

# FITTINGS



**Weld Fittings**



## WELD FITTINGS....

Weld Fittings are used on permanent installations where process piping and equipment can be cleaned in place (CIP) and removal from the system is not required. Weld Fittings are offered in nominal tube sizes 1/2" through 8" in T304 and T316L materials. Uniform wall thickness for 1/2" through 3" sizes measure .065 (16 ga). In 4" size, wall thickness measures .083 (14 ga), 6" and 8" .109 (12 ga).

VNE offers Polished ID and OD Fittings for immediate shipment. Other polished combinations may be ordered. Our Weld Fittings meet all 3A requirements.

## WELD FITTING SPECIFICATIONS....

**Size Range:** 1/2" OD through 8" OD

**Materials:** T304  
T316L

**Finish:** No. 7 - ID & OD  
No. 5 - OD only  
No. 3 - ID only  
No. 1 - unpolished

## ORDERING SPECIFICATIONS....

**Specify:**

- Quantity
- Product description or Part No.
- Size
- Material Type
- Polish Requirements

## LIMITED WARRANTY....

VNE Corporation products are warranted to be free from defects in material and workmanship for a period of one year from the date of shipment. Any product that proves to be defective shall be repaired or replaced at the option of VNE, providing it has been used as recommended and in strict accordance with recognized piping practices, and that has not been subject to extraordinary service, such as encountered under severe corrosive or abrasive conditions.

VNE makes no warranties, express or implied, other than those listed above.

VNE shall not be liable for any consequential, indirect, incidental or contingent damages.

## VNE CORPORATION

P.O. Box 1698 • 1149 Barberry Drive • Janesville, WI 53547

TEL: 608-756-4930 • FAX: 608-756-3643 • 1-800-356-1111 • Web site: [vnestainless.com](http://vnestainless.com)

### WELD FITTINGS

VNE	TRI-CLOVER	WAUKESHA	G & H	JENSEN
E2S	L2S	2CW	G2S	J2S
E2C	L2CM	2CKW	G2C	J2CM
E2T	L2C	2TW	G2T	J2C
E2F	L2F	2FW	G2F	J2F
E2KS	L2KS	2KW	G2KS	J2KS
E2KC	L2KM	2KKW	G2KC	J2KM
E2KT	L2K	2KT	G2KT	J2K
E2KP	L2P	2KP	G2KP	J2P
E2WU	L2WU	2WU	G2WU	J2WU
E7WWW	L7WWW	7W	G7WWW	J7WWW
E7WWC	L7WWM	7WWK	G7WWC	J7WWM
E7WWT	L7WWT	7WWT	G7WWT	J7WWT
E7WCW	L7WMW	7WKW	G7WCW	J7WMW
E7WTW	L7WTW	7WTW	G7WTW	J7WTW
E7WCC	L7WMM	7WKK	G7WCC	J7WMM
E7WTT	L7WTT	7WTT	G7WTT	J7WTT
E7CCW	L7MMW	7KKW	G7CCW	J7MMW
E7TTW	L7TTW	7TTW	G7TTW	J7TTW
E7RWWW	L7RWWW	7WR	G7RWWW	J7RWWW
E9WWWWW	L9WWWWW	9W	G9WWWWW	J9WWWWW
E31WW	L31	31W	G31	J31
E32WW	L32	32W	G32	J32
E28WA	L28WA	28WA	G28WA	J28WA
E28WB	L28WB	28WB	G28WB	J28WB

### 2WCL - 90° ELBOW SHORT TANGENT

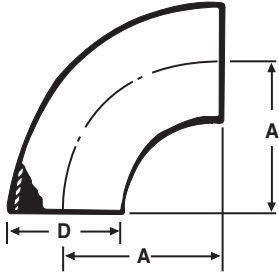

Size Tube OD	A	D	Nom. Wall
1	1.500	1.000	0.065
1 1/4	1.875	1.250	0.065
1 1/2	2.250	1.500	0.065
2	3.000	2.000	0.065
2 1/2	3.750	2.500	0.065
3	4.500	3.000	0.065
4	6.000	4.000	0.083
6	9.000	6.000	0.109
8	12.000	8.000	0.109

### E2S - 90° ELBOW

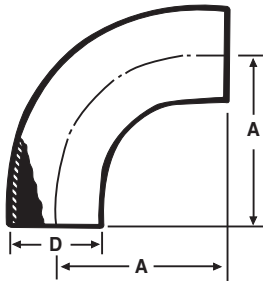

Size Tube OD	A	D	Nom. Wall
1	2.062	1.000	0.065
1 1/2	2.937	1.500	0.065
2	4.062	2.000	0.065
2 1/2	5.187	2.500	0.065
3	6.312	3.000	0.065
4	8.312	4.000	0.083

### E2C - 90° ELBOW

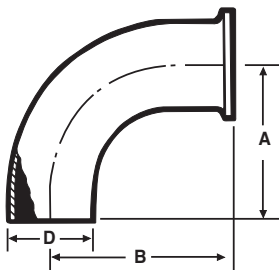

Size Tube OD	A	B	D	Nom. Wall
1	2.062	2.562	1.000	0.065
1 1/2	2.935	3.437	1.500	0.065
2	4.062	4.562	2.000	0.065
2 1/2	5.187	5.687	2.500	0.065
3	6.312	6.812	3.000	0.065
4	8.312	8.937	4.000	0.083
6	9.000	9.875	6.000	0.109

### E2F - 90° ELBOW

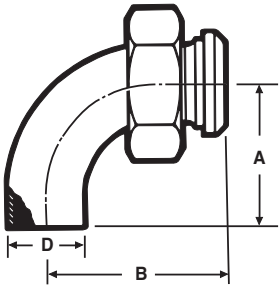

Size Tube OD	A	B	D	Nom. Wall
1	2.062	2.750	1.000	0.065
1 1/2	2.937	3.656	1.500	0.065
2	4.062	4.781	2.000	0.065
2 1/2	5.187	6.031	2.500	0.065
3	6.937	7.218	3.000	0.065
4	8.937	9.531	4.000	0.083

### E2T - 90° ELBOW

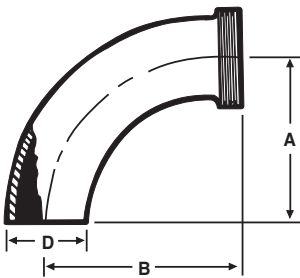

Size Tube OD	A	B	D	Nom. Wall
1	2.062	2.750	1.000	0.065
1 1/2	2.937	3.656	1.500	0.065
2	4.062	4.781	2.000	0.065
2 1/2	5.187	6.031	2.500	0.065
3	6.937	7.218	3.000	0.065
4	8.937	9.531	4.000	0.083

### E2WU - 180° U BEND

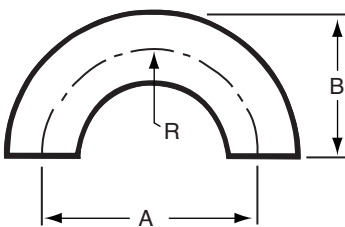

Size Tube OD	A	B	C	R	Nom. Wall
1/2	1.500	1.000	0.500	0.750	0.065
3/4	2.250	1.500	0.750	1.125	0.065
1	3.000	2.000	1.000	1.500	0.065
1 1/4	3.750	2.500	1.250	1.875	0.065
1 1/2	4.500	3.000	1.500	2.250	0.065
2	6.000	4.000	2.000	3.000	0.065
2 1/2	7.500	5.000	2.500	3.750	0.065
3	9.000	6.000	3.000	4.500	0.065
4	12.000	8.000	4.000	6.000	0.083
6	18.000	12.000	6.000	9.000	0.109

## E2WK - 45° ELBOW SHORT TANGENT

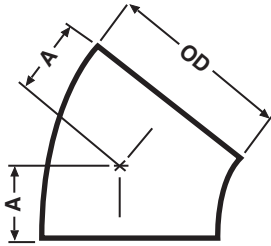

Size Tube OD	A	Nom. Wal
1	0.625	0.065
1 1/4	0.781	0.065
1 1/2	0.937	0.065
2	1.250	0.065
2 1/2	1.562	0.065
3	1.875	0.065
4	2.500	0.083
6	3.750	0.109
8	5.000	0.109

## E2KS - 45° ELBOW

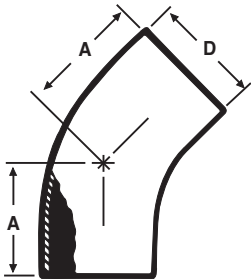

Size Tube OD	A	D	Nom. Wall
1	1.187	1.000	0.065
1 1/2	1.625	1.500	0.065
2	2.312	2.000	0.065
2 1/2	3.000	2.500	0.065
3	3.687	3.000	0.065
4	4.812	4.000	0.083

## E2KC - 45° ELBOW

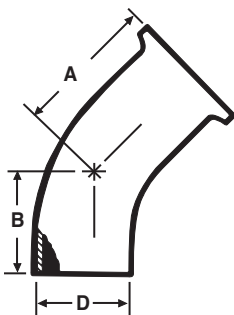

Size Tube OD	A	B	D	Nom. Wall
1	1.687	1.187	1.000	0.065
1 1/2	2.125	1.625	1.500	0.065
2	2.812	2.312	2.000	0.065
2 1/2	3.500	3.000	2.500	0.065
3	4.187	3.687	3.000	0.065
4	5.437	4.812	4.000	0.083
6	4.625	3.750	6.000	0.109

# WELD FITTINGS

## STAINLESS STEEL FITTINGS PRODUCT CATALOG

### E2KT - 45° ELBOW

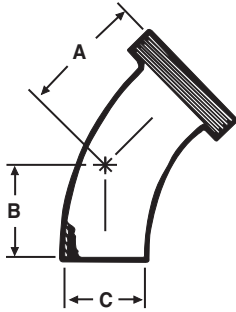

Size Tube OD	A	B	C	Nom. Wall
1	1.875	1.187	1.000	0.065
1 1/2	2.343	1.625	1.500	0.065
2	3.031	2.312	2.000	0.065
2 1/2	3.843	3.000	2.500	0.065
3	4.593	3.687	3.000	0.065
4	6.031	4.812	4.000	0.083

### E2KP - 45° ELBOW

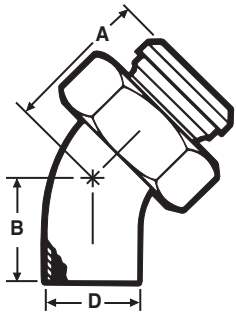

Size Tube OD	A	B	D	Nom. Wall
1	1.875	1.187	1.000	0.065
1 1/2	2.343	1.625	1.500	0.065
2	3.031	2.312	2.000	0.065
2 1/2	3.843	3.000	2.500	0.065
3	4.593	3.687	3.000	0.065
4	6.031	4.812	4.000	0.083

### E7WWW - TEE

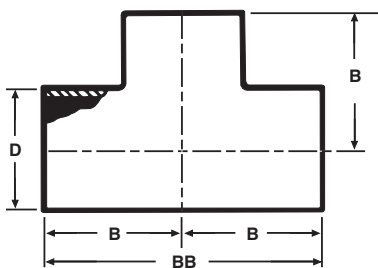

Size Tube OD	B	BB	D	Nom. Wall
1	1.125	2.250	1.000	0.065
1 1/4	2.250	3.312	1.250	0.065
1 1/2	1.656	3.312	1.500	0.065
2	2.062	4.125	2.000	0.065
2 1/2	2.343	4.687	2.500	0.065
3	2.593	5.187	3.000	0.065
4	3.437	6.875	4.000	0.083
6	5.625	11.250	6.000	0.109
8	7.000	14.000	8.000	0.109

### E7RWWW - REDUCING TEE

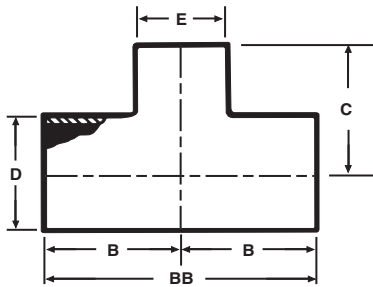

Size Tube OD	B	BB	C	Nom. Wall
1 1/2 x 1	1.650	3.312	1.375	0.065
2 x 1	2.060	4.125	1.625	0.065
2 x 1 1/2	2.060	4.125	1.906	0.065
2 1/2 x 1	2.340	4.687	1.875	0.065
2 1/2 x 1 1/2	2.340	4.687	2.150	0.065
2 1/2 x 2	2.340	4.687	2.312	0.065
3 x 1	2.590	5.187	2.125	0.065
3 x 1 1/2	2.590	5.187	2.400	0.065
3 x 2	2.590	5.187	2.562	0.065
3 X 2 1/2	2.590	5.187	2.590	0.065
4 x 1 1/2	3.430	6.875	4.906	0.083 x 0.065
4 x 2	3.430	6.875	3.090	0.083 x 0.065
4 x 2 1/2	3.430	6.875	3.090	0.083 x 0.065
4 x 3	3.590	6.875	3.090	0.083 x 0.065
6 x 2	5.625	11.250	5.625	0.109 x 0.065
6 x 3	5.625	11.250	5.625	0.109 x 0.065
6 x 4	5.625	11.250	5.625	0.109 x 0.083

### E7WWCS - SHORT CLAMP BRANCH TEE - See TE7WWCS

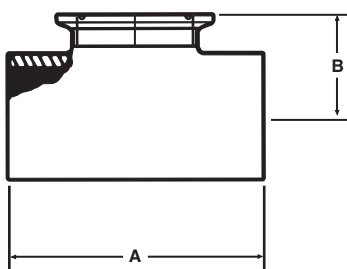

Size Tube OD	A	B	Nom. Wall
1	4.250	1.125	.065
1 1/2	4.750	1.375	.065
2	5.750	1.625	.065
2 1/2	6.250	1.875	.065
3	6.750	2.125	.065
4	8.250	2.750	.083
6	11.250	4.625	.109



### E7RWWCS - REDUCING SHORT CLAMP BRANCH TEE

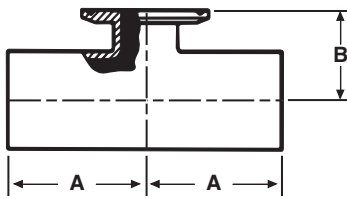

Size Tube OD	A	B	Nom. Wall
3/4 x 1/2	2.000	1.000	0.065
1 x 1/2	2.120	1.120	0.065
1 x 3/4	2.120	1.120	0.065
1 1/2 x 1/2	2.370	1.370	0.065
1 1/2 x 3/4	2.370	1.370	0.065
1 1/2 x 1	2.370	1.370	0.065
2 x 1/2	2.870	1.620	0.065
2 x 3/4	2.870	1.620	0.065
2 x 1	2.870	1.620	0.065
2 x 1 1/2	2.870	1.620	0.065
2 1/2 x 1/2	3.120	1.870	0.065
2 1/2 x 3/4	3.120	1.870	0.065
2 1/2 x 1	3.120	1.870	0.065
2 1/2 x 1 1/2	3.120	1.870	0.065
2 1/2 x 2	3.120	1.870	0.065
3 x 1/2	3.370	2.120	0.065
3 x 3/4	3.370	2.120	0.065
3 x 1	3.370	2.120	0.065
3 x 1 1/2	3.370	2.120	0.065
3 x 2	3.370	2.120	0.065
3 x 2 1/2	3.370	2.120	0.065
4 x 1/2	4.120	2.620	0.083
4 x 3/4	4.120	2.620	0.083
4 x 1	4.120	2.620	0.083
4 x 1 1/2	4.120	2.620	0.083
4 x 2	4.120	2.620	0.083
4 x 2 1/2	4.120	2.620	0.083
4 x 3	4.120	2.620	0.083
6 x 4	5.630	3.750	0.109

### E7WWC - TEE WELD X WELD X CLAMP

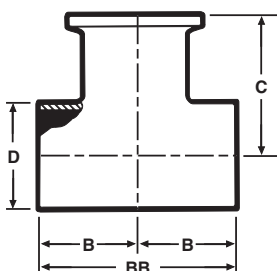

Size Tube OD	B	BB	C	D	Nom. Wall
1	1.125	2.250	1.625	1.000	0.065
1 1/2	1.656	3.312	2.156	1.500	0.065
2	2.062	4.125	2.562	2.000	0.065
2 1/2	2.343	4.687	2.843	2.500	0.065
3	2.593	5.187	3.093	3.000	0.065
4	3.625	7.250	4.656	4.000	0.083
6	5.625	11.250	6.500	6.000	0.109

### E7WWT - TEE WELD X WELD X THREAD

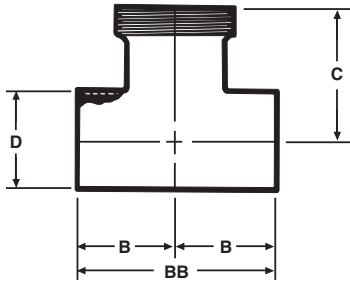

Size Tube OD	B	BB	C	D	Nom. Wall
1	1.125	2.250	1.812	1.000	0.065
1 1/2	1.656	3.312	2.375	1.500	0.065
2	2.062	4.125	2.781	2.000	0.065
2 1/2	2.343	4.687	3.187	2.500	0.065
3	2.593	5.187	3.500	3.000	0.065
4	3.625	7.250	4.656	4.000	0.083

### E7WCW - TEE WELD X CLAMP X WELD

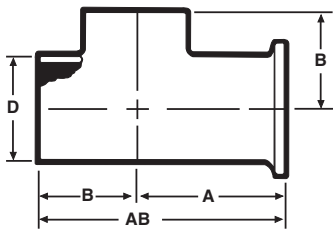

Size Tube OD	A	B	AB	D	Nom. Wall
1	1.625	1.125	2.750	1.000	0.065
1 1/2	2.156	1.656	3.812	1.500	0.065
2	2.562	2.062	4.625	2.000	0.065
2 1/2	2.843	2.343	5.187	2.500	0.065
3	3.093	2.593	5.687	3.000	0.065
4	4.250	3.625	7.875	4.000	0.083
6	6.500	5.625	12.125	6.000	0.109

### E7WTW - TEE THREADED ONE END - WELD X THREAD X WELD

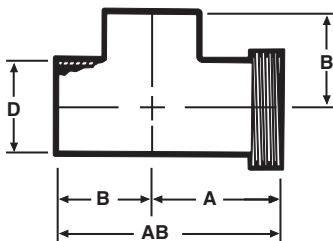

Size Tube OD	A	B	AB	D	Nom. Wall
1	1.812	1.125	2.937	1.000	0.065
1 1/2	2.375	1.656	4.031	1.500	0.065
2	2.781	2.062	4.843	2.000	0.065
2 1/2	3.187	2.343	5.531	2.500	0.065
3	3.500	2.593	6.093	3.000	0.065
4	4.656	3.625	8.281	4.000	0.083

### E7WCC - TEE WELD X CLAMP X CLAMP

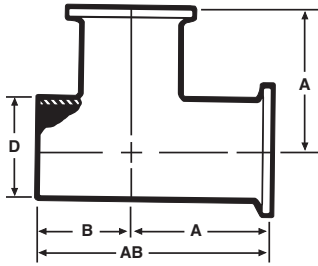

Size Tube OD	A	B	AB	D	Nom. Wall
1	1.625	1.125	2.750	1.000	0.065
1 1/2	2.156	1.656	3.812	1.500	0.065
2	2.562	2.062	4.625	2.000	0.065
2 1/2	2.843	2.343	5.187	2.500	0.065
3	3.093	2.593	5.687	3.000	0.065
4	4.250	3.625	7.875	4.000	0.083
6	6.500	5.625	12.125	6.000	0.109

### E7WTT - TEE WELD X THREAD X THREAD

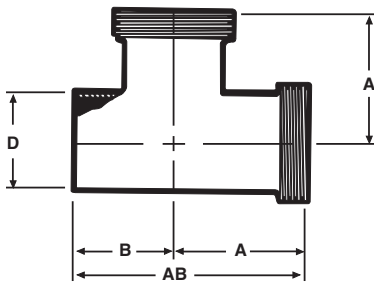

Size Tube OD	A	B	AB	D	Nom. Wall
1	1.812	1.125	2.937	1.000	0.065
1 1/2	2.375	1.656	4.031	1.500	0.065
2	2.781	2.062	4.843	2.000	0.065
2 1/2	3.187	2.343	5.531	2.500	0.065
3	3.500	2.593	6.093	3.000	0.065
4	4.656	3.625	8.281	4.000	0.083

### E7CCW - TEE CLAMP X CLAMP X WELD

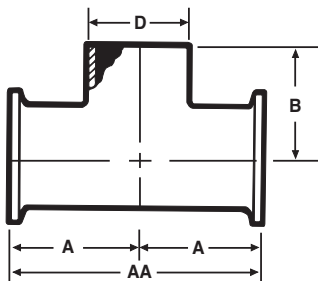

Size Tube OD	A	AA	B	D	Nom. Wall
1	1.625	3.250	1.125	1.000	0.065
1 1/2	2.562	4.312	1.656	1.500	0.065
2	2.562	5.125	2.062	2.000	0.065
2 1/2	2.843	5.687	2.343	2.500	0.065
3	3.093	6.187	2.593	3.000	0.065
4	4.250	8.500	3.625	4.000	0.083
6	6.500	13.000	5.625	6.000	0.109

### E7TTW - TEE THREAD X THREAD X WELD

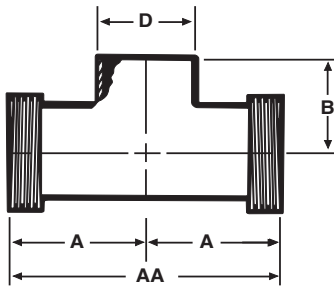

Size Tube OD	A	AA	B	D	Nom. Wall
1	1.812	3.625	1.125	1.000	0.065
1 1/2	2.375	4.750	1.656	1.500	0.065
2	2.781	5.562	2.062	2.000	0.065
2 1/2	3.187	6.375	2.343	2.500	0.065
3	3.500	7.000	2.593	3.000	0.065
4	4.656	9.312	3.625	4.000	0.083

### E9WWW - CROSS

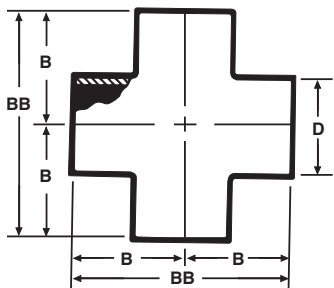

Size Tube OD	B	BB	D	Nom. Wall
1	1.125	2.250	1.000	.065
1 1/2	1.656	3.312	1.500	.065
2	2.062	4.125	2.000	.065
2 1/2	2.343	4.687	2.500	.065
3	2.593	5.187	3.000	.065
4	3.437	6.875	4.000	.083
6	5.625	11.250	6.000	.109

### E14WA - TYPE A STUB END WITH GROOVES

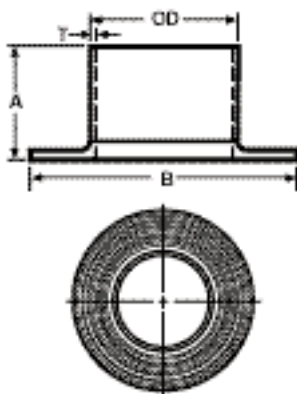

Size Tube OD	A	B	Nom. Wall ( T )
1/2	1.375	1.625	0.065
3/4	1.375	1.687	0.065
1	1.625	2.000	0.065
1 1/4	1.625	2.500	0.065
1 1/2	1.750	2.875	0.065
2	1.500	3.625	0.065
2 1/2	2.000	4.125	0.065
3	2.250	5.000	0.065
4	2.625	6.187	0.083
6	3.000	8.500	0.109

### E16W - WELD CAP

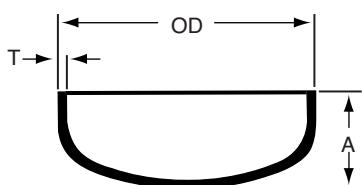

Size Tube OD	A	Nom. Wall ( T )
1	0.375	0.065
1 1/4	0.500	0.065
1 1/2	0.562	0.065
2	0.750	0.065
2 1/2	1.000	0.065
3	1.250	0.065
4	1.500	0.083
6	Contact VNE for dimensions	

### E28WA - 45° LATERAL

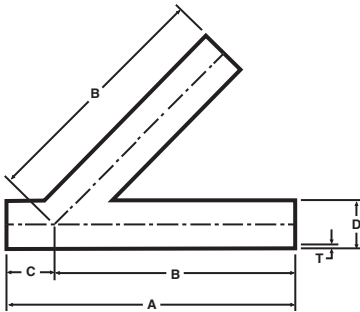

Size Tube OD	A	B	C	D	Nom. Wall (T)
1	6.000	5.000	1.000	1.000	0.065
1 1/2	7.375	6.187	1.187	1.500	0.065
2	8.625	7.125	1.500	2.000	0.065
2 1/2	10.125	8.500	1.625	2.500	0.065
3	10.750	8.875	1.875	3.000	0.065
4	12.812	10.750	2.062	4.000	0.083
6	18.000	14.500	3.500	6.000	0.109

### E28WB - TRUE Y

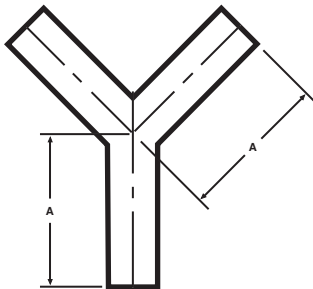

Size Tube OD	A	Nom. Wall
1	3.000	0.065
1 1/2	3.000	0.065
2	4.000	0.065
2 1/2	5.000	0.065
3	6.000	0.065
4	8.000	0.083
6	8.000	0.109

### E28RWA - 45° REDUCING LATERAL

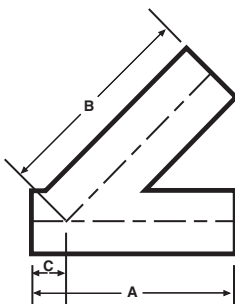

Size Tube OD	A	B	C	Nom. Wall
1 1/2 x 1	7.375	6.187	1.187	0.065
2 x 1	8.625	7.125	1.625	0.065
2 x 1 1/2	8.625	7.125	1.625	0.065
2 1/2 x 1	10.125	8.500	1.500	0.065
2 1/2 x 1 1/2	10.125	8.500	1.500	0.065
2 1/2 x 2	10.125	8.500	1.500	0.065
3 x 1	10.750	8.875	1.875	0.065
3 x 1 1/2	10.750	8.875	1.875	0.065
3 x 2	10.750	8.875	1.875	0.065
3 x 2 1/2	10.750	8.875	1.875	0.065
4 x 1	12.812	10.750	2.062	0.083 x .065
4 x 1 1/2	12.812	10.750	2.062	0.083 x .065
4 x 2	12.812	10.750	2.062	0.083 x .065
4 x 2 1/2	12.812	10.750	2.062	0.083 x .065
4 x 3	12.812	10.750	2.062	0.083 x .065

### E31WW - CONCENTRIC REDUCER

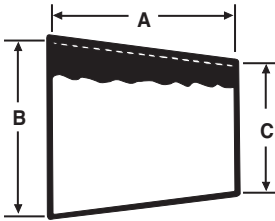

Size Tube OD	A	B	C	Nom. Wall
3/4 x 1/2	*	0.750	0.500	0.065
1 x 1/2	*	1.000	0.500	0.065
1 x 3/4	*	1.000	0.750	0.065
1 1/2 x 1/2	*	1.500	0.500	0.065
1 1/2 x 3/4	*	1.500	0.750	0.065
1 1/2 x 1	2.000	1.500	1.000	0.065
1 1/2 x 1 1/4	1.000	1.500	1.250	0.065
2 x 1	4.000	2.000	1.000	0.065
2 x 1 1/4	3.000	2.000	1.250	0.065
2 x 1 1/2	2.000	2.000	1.500	0.065
2 1/2 x 1 1/2	4.000	2.500	1.500	0.065
2 1/2 x 2	2.000	2.500	2.000	0.065
3 x 1 1/2	6.000	3.000	1.500	0.065
3 x 2	4.000	3.000	2.000	0.065
3 x 2 1/2	2.000	3.000	2.500	0.065
4 x 2	8.000	4.000	2.000	0.083 x .065
4 x 2 1/2	6.000	4.000	2.500	0.083 x .065
4 x 3	4.000	4.000	3.000	0.083 x .065
6 x 2	5.500	6.000	2.000	0.109 x .065
6 x 3	5.500	6.000	3.000	0.109 x .083
6 x 4	5.500	6.000	4.000	0.109 x .083

\* Contact VNE for dimensions.

### E31CW - CONCENTRIC REDUCER CLAMP X WELD

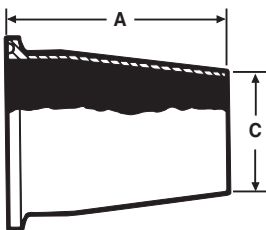

Size Tube OD	A	C	Nom. Wall
1 1/2 x 1	2.500	1.000	0.065
2 x 1 1/2	2.500	1.500	0.065
2 1/2 x 1 1/2	4.500	1.500	0.065
2 1/2 x 2	2.500	2.000	0.065
3 x 2	4.500	2.000	0.065
3 x 2 1/2	2.500	2.500	0.065
4 x 2	8.625	2.000	0.065
4 x 2 1/2	6.625	2.500	0.065
4 x 3	4.625	3.000	0.065
6 x 4	6.375	4.000	0.083

### E31PW - CONCENTRIC REDUCER PLAIN BEVEL X WELD

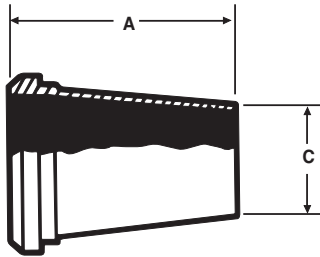

Size Tube OD	A	C	Nom. Wall
1 1/2 x 1	2.687	1.000	0.065
2 x 1 1/2	2.718	1.500	0.065
2 1/2 x 1 1/2	4.843	1.500	0.065
2 1/2 x 2	2.843	2.000	0.065
3 x 2	4.937	2.000	0.065
3 x 2 1/2	2.937	2.500	0.065
4 x 2	9.000	2.000	0.065
4 x 2 1/2	7.000	2.500	0.065
4 x 3	5.000	3.000	0.065

### E32WW - ECCENTRIC REDUCER

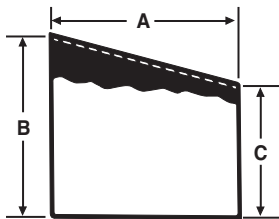

Size Tube OD	A	B	C	Nom. Wall
3/4 x 1/2	*	0.750	0.500	0.065
1 x 1/2	*	1.000	0.500	0.065
1 x 3/4	*	1.000	0.750	0.065
1 1/2 x 1/2	*	1.500	0.500	0.065
1 1/2 x 3/4	*	1.500	0.750	0.065
1 1/2 x 1	2.000	1.500	1.000	0.065
1 1/2 x 1 1/4	1.000	1.500	1.250	0.065
2 x 1	4.000	2.000	1.250	0.065
2 x 1 1/4	3.000	2.000	1.250	0.065
2 x 1 1/2	2.000	2.000	1.500	0.065
2 1/2 x 1 1/2	4.000	2.500	1.500	0.065
2 1/2 x 2	2.000	2.500	2.000	0.065
3 x 2	4.000	3.000	2.000	0.065
3 x 2 1/2	2.000	3.000	2.500	0.065
4 x 2	8.000	4.000	2.000	0.083 x .065
4 x 2 1/2	6.000	4.000	2.500	0.083 x .065
4 x 3	4.000	4.000	3.000	0.083 x .065
6 x 2	5.500	6.000	2.000	0.109 x .065
6 x 3	5.500	6.000	3.000	0.109 x .083
6 x 4	5.500	6.000	4.000	0.109 x .083

\* Contact VNE for dimensions.

### E32CW - ECCENTRIC REDUCER CLAMP X WELD

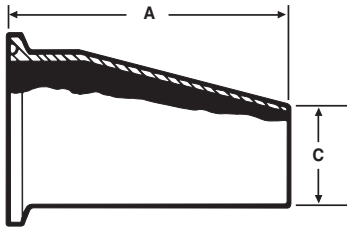

Size Tube OD	A	C	Nom. Wall
1 1/2 X 1	2.500	1.000	0.065
2 x 1 1/2	2.500	1.500	0.065
2 1/2 x 1 1/2	4.500	1.500	0.065
2 1/2 x 2	2.500	2.000	0.065
3 x 2	4.500	2.000	0.065
3 x 2 1/2	2.500	2.500	0.065
4 x 2	8.625	2.000	0.065
4 x 2 1/2	6.625	2.500	0.065
4 x 3	4.625	3.000	0.065
6 x 4	6.375	4.000	0.083

### E17WW-6L - TUBE X PIPE ADAPTER

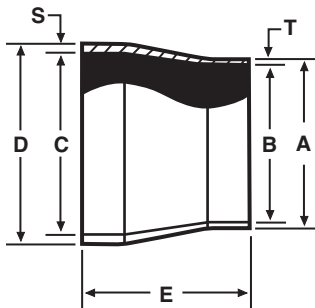

Size Tube OD	A	B	SCH5 C	SCH10 C	SCH40 C	D
1/2	0.500	0.370	0.710	0.674	0.622	0.840
3/4	0.750	0.620	0.920	0.884	0.824	1.050
1	1.000	0.870	1.185	1.097	1.049	1.315
1 1/2	1.500	1.370	1.770	1.682	1.610	1.900
2	2.000	1.870	2.245	2.157	2.067	2.375
2 1/2	2.500	2.370	2.709	2.635	2.469	2.875
3	3.000	2.870	3.334	3.260	3.068	3.500
4	4.000	3.834	4.334	4.260	4.026	4.500
6	6.000	5.782	6.407	6.357	6.065	6.625

Size Tube OD	E	T	SCH5 S	SCH10 S	SCH40 S
1/2	1.000	0.065	0.065	0.083	0.109
3/4	1.000	0.065	0.065	0.083	0.113
1	1.000	0.065	0.065	0.109	0.133
1 1/2	1.500	0.065	0.065	0.109	0.145
2	1.500	0.065	0.065	0.109	0.154
2 1/2	1.500	0.065	0.083	0.120	0.203
3	2.000	0.065	0.083	0.120	0.216
4	2.000	0.083	0.083	0.120	0.237
6	3.000	0.109	0.109	0.134	0.280